



**Medtronic**

# CD HORIZON<sup>®</sup> SEXTANT<sup>®</sup> II

Rod Insertion System

## Surgical Technique

**As described by:**

Kevin Foley, MD  
Department of Neurosurgery  
University of Tennessee  
Memphis, Tennessee

David Rouben, MD  
River City Orthopaedic Surgeons  
Louisville, Kentucky

Najeeb Thomas, MD  
Department of Neurosurgery  
Ochsner Clinic Foundation  
New Orleans, Louisiana



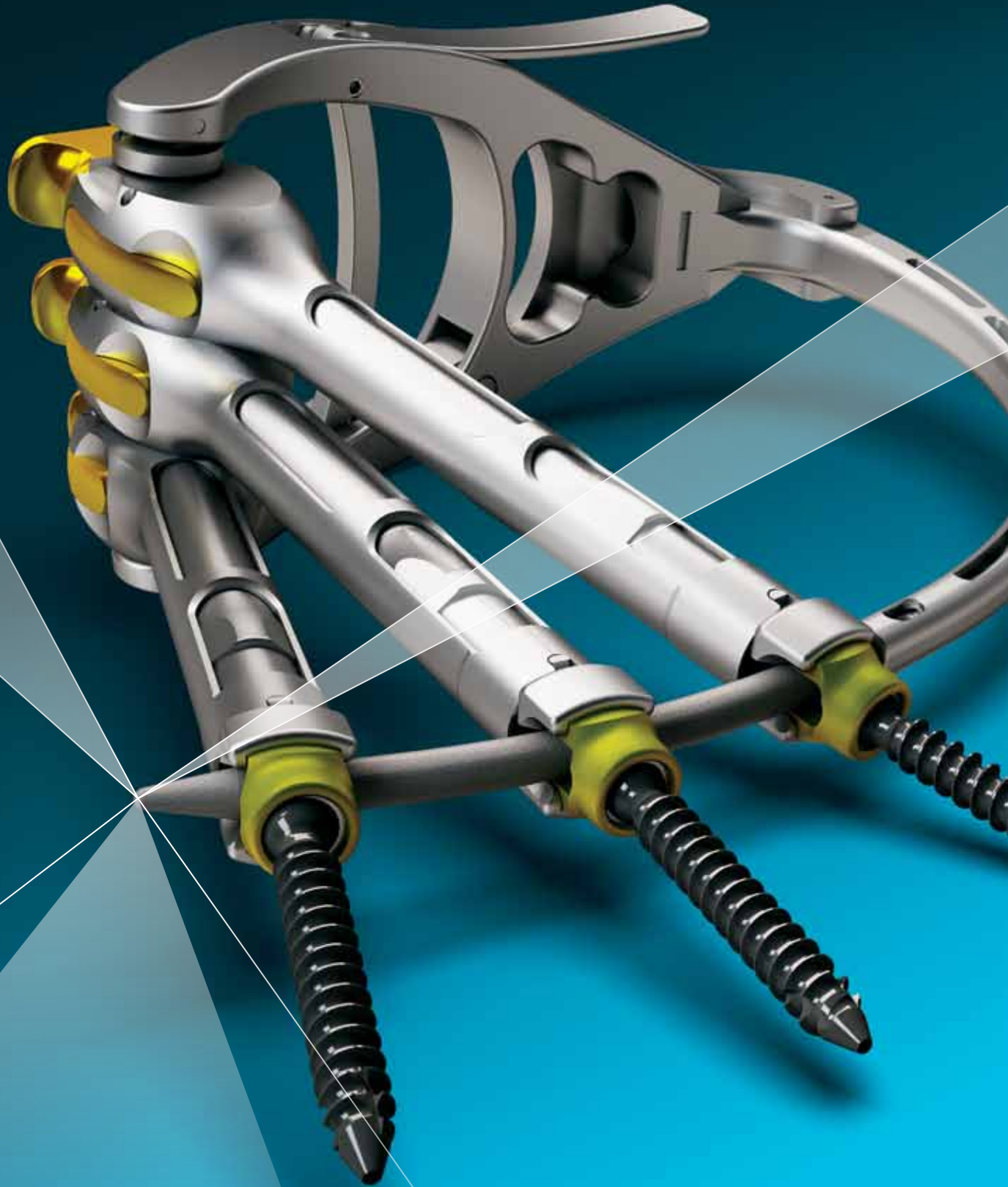



# CD HORIZON<sup>®</sup> SEXTANT<sup>®</sup> II

Rod Insertion System

## Surgical Technique

Instruments	2
Instruments and Implants	4
Preliminary Steps	
Preoperative Planning and Set Up	6
Positioning of Skin Incisions	7
Considering Pedicle Anatomy	8
Considering Navigation Options—FluoroNav <sup>®</sup> MAST™ Spinal Procedural Solution	9
Surgical Technique Steps — One-Level Procedure	
Accessing the Pedicle	10
Guidewire Insertion	11
Dilating the Fascia	12
Pedicle Preparation	13
Screw Extender Assembly	15
Screw Insertion	18
Second Screw Insertion	19
Connecting the Extenders	20
Attaching the Rod Inserter to Screw Extenders	21
Passing the Trocar	23
Measuring the Rod	24
Passing the Rod	25
Set Screw Insertion and Final Break-Off	26
Removing Assembly	29
Closure, Graft Placement and Explantation	30
Surgical Technique Steps — Two-Level Procedure	
Accessing the Pedicle	32
Freehand Method	33
Alignment Guide Method	33
Screw Extender Assembly	34
Screw Insertion	35
Connecting Extenders	37
Attaching Rod Inserter to Screw Extenders	38
Passing the Rod	40
Important Product Information	41

## Instruments



CD HORIZON® SEXTANT® II  
Rod Inserter (7575300)



One-Level Extender A (75753039)  
One-Level Extender B (75753049)



Two-Level Outer Extenders (75753019)  
Two-Level Middle Extender (75753029)



Inner Sleeves (75753059)

## Instruments *continued*



*Dilator (8675422)*



*5.6mm Dilator (9560420)*



*Large Disposable Dilator (8675424)*



*9.3mm Dilator (9560421)*



*4.5, 5.5, 6.5, 7.5mm Taps  
4.5–5.5mm, 5.5–6.5mm Self-drilling, Tapered Taps*



*Cannulated Bonescrew Driver (7570021)  
Ball-end Bonescrew Driver (7570022)  
Retaining Bonescrew Driver (7570023)  
T27 Removal Driver (7570088)*



*Quick-Connect Ratcheting Handle (9339082)  
Quick-Connect Ratcheting T-Handle (7579000)*



*Radiolucent Clamp (7575307)  
Alignment Guide (7575306)*



*Rod Trocar Tip (8670031)*

## Instruments and Implants

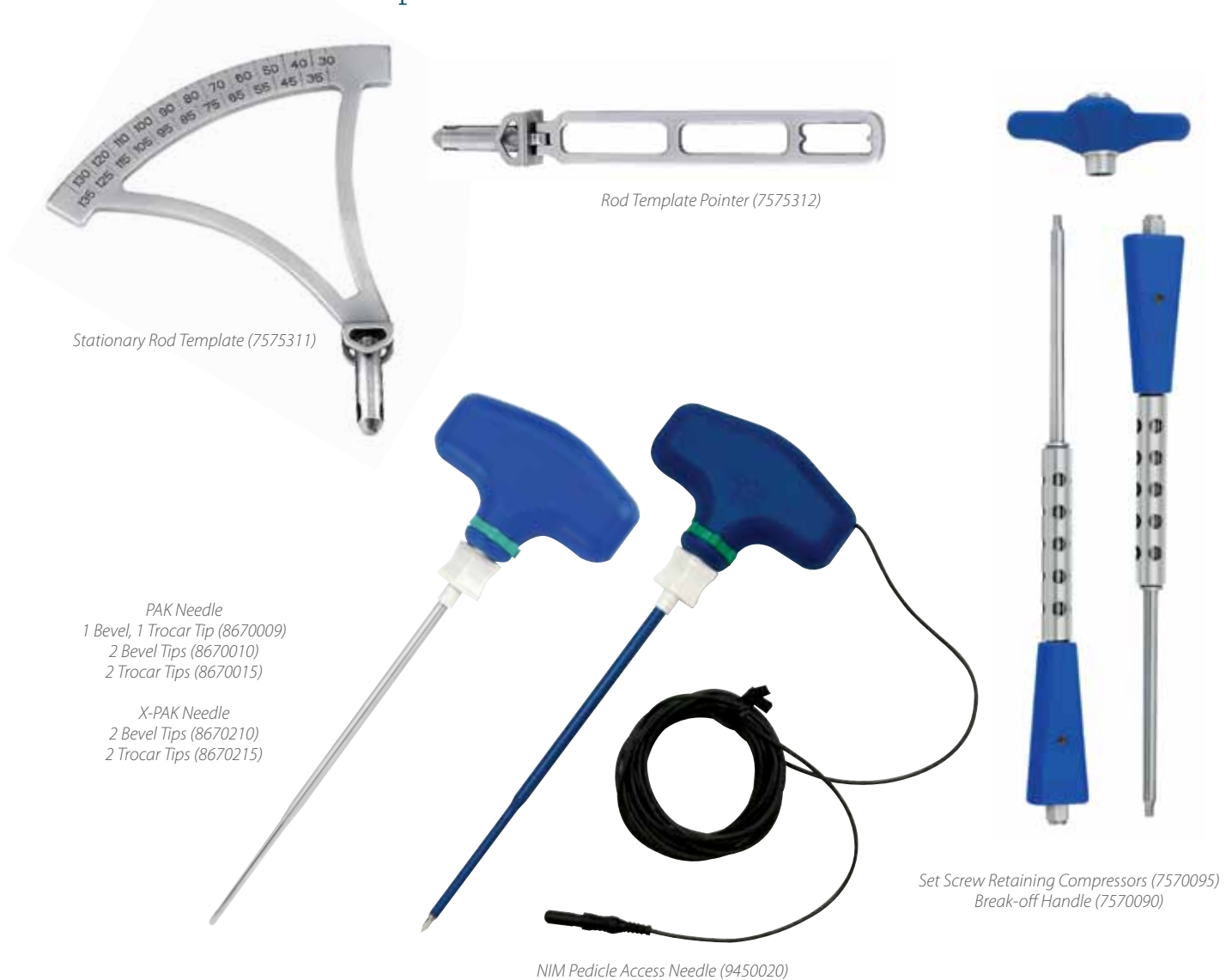

Guidewires: Sharp (8670002)  
 Blunt (8670001)

## Implants



# CD HORIZON® SEXTANT® II

Rod Insertion System

---

One-Level  
Surgical Steps



## STEP 1 | Preoperative Planning and Set Up

Preoperative planning can be useful in determining the proper starting point and screw trajectory. An axial view demonstrates the distance lateral to the pedicle initially taken through the skin (Figure 1).

### Tip

*The starting point is rarely directly over the pedicle.*

*Some tables have pedestals that make it difficult to get a true AP view of the pedicles, especially at the S1 level. While adjustments in patient positioning can be made, tables that limit good AP fluoroscopy should generally be avoided. A longer prep area is also necessary for intraoperative flexibility.*

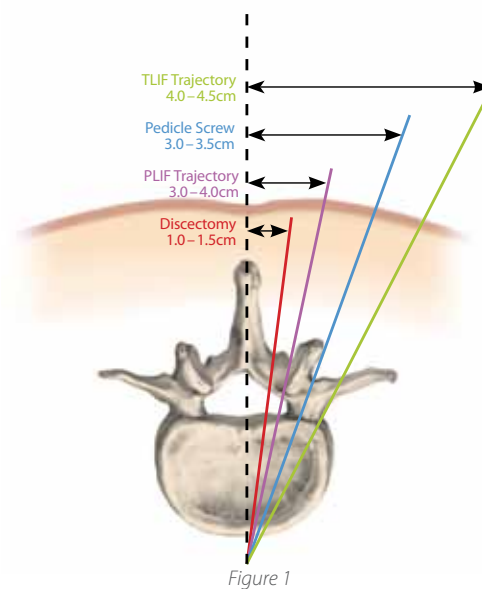

Figure 1

When using the CD HORIZON® SEXTANT® II Rod Insertion System, the patient should be positioned prone, lying flat on the table. Either a radiolucent frame or chest rolls may be used, but a knee-to-chest position should be avoided. Verify that adequate fluoroscopic images of the pedicles can be obtained in both an AP and lateral view before proceeding (Figure 2). To adequately view the S1 pedicle, a Ferguson view presents the best image.

### Tip

*On AP fluoroscopy, the spinous processes should lay midway between both pedicles.*

*On AP fluoroscopy, the end plates should be linear and not rounded.*

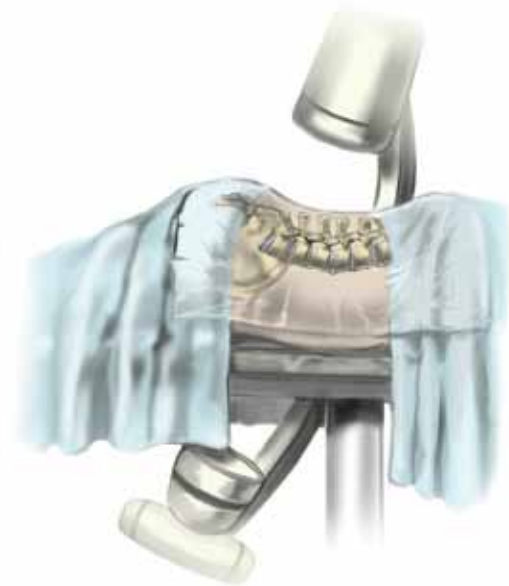

Figure 2



## STEP 2 | Positioning of Skin Incisions

A 22-gauge spinal needle may be used to verify the appropriate location of the skin incisions. The needle is positioned on the skin directly over the pedicle on an AP image. The needle is then moved laterally 1 cm to 2 cm and inserted through the skin to the intersection of the facet and transverse process (Figures 3A and 3B).

### ✓ Tip

*The skin incision is slightly lateral to the pedicle on fluoroscopy. This will help to ensure the needle follows the normal lateral to medial trajectory of the pedicle.*

Both AP and lateral images confirm that the appropriate starting place has been determined (Figures 4A and 4B).



Figure 3A

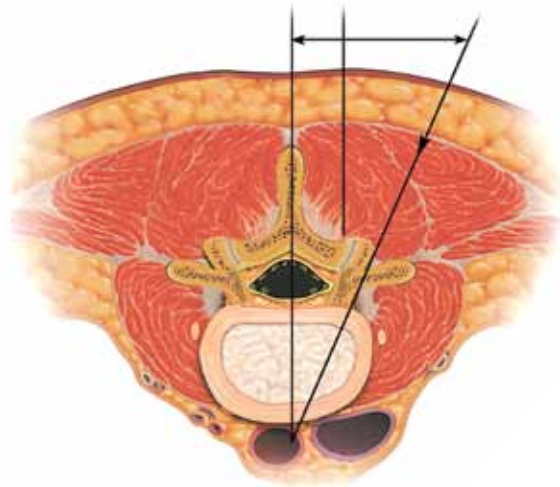

Figure 3B



Figure 4A



Figure 4B

## STEP 3 | Considering Pedicle Anatomy

Consider the pedicle as roughly a cylindrical structure.

As the pedicle is traversed, the trajectory should allow the needle or screw to remain lateral to the medial pedicle wall (**Figure 5**).

### ✓ Tip

The ideal starting point is at the intersection of the facet and the transverse process (the lateral edge of the cylinder) (**Figures 6A and 6B**).

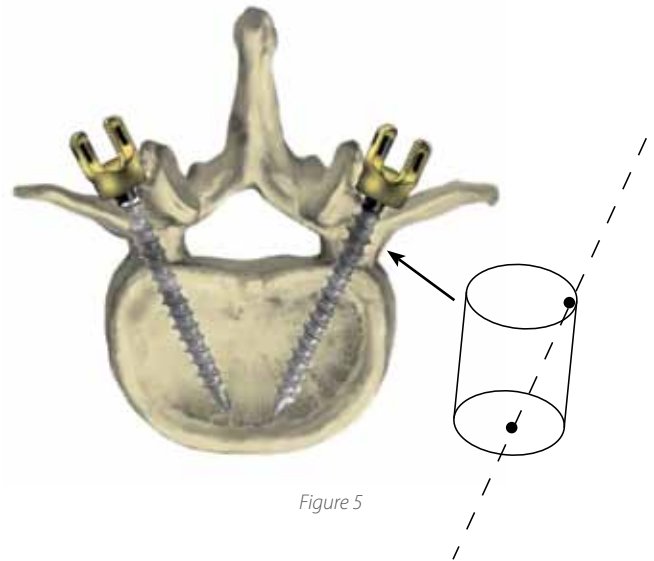

Figure 5

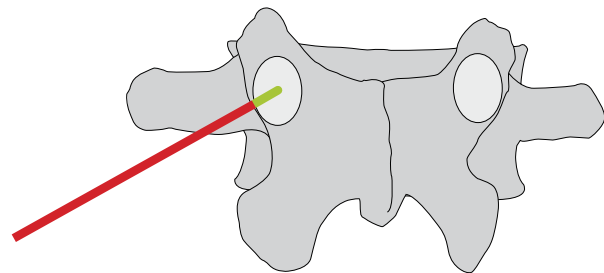

Figure 6A

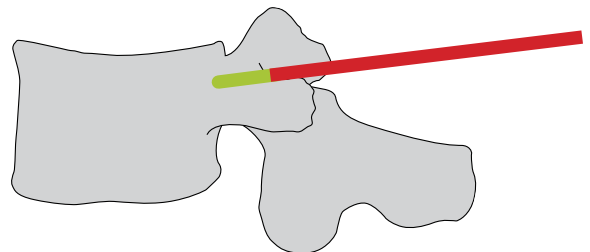

Figure 6B

## STEP 4 | Considering Navigation Options

The FluoroNav® MAST™ Spinal Procedural Solution can also provide assistance with pedicle navigation (**Figures 7A and 7B**). The CD HORIZON® SEXTANT® II instrumentation is designed to work interchangeably with the FluoroNav® MAST™ Spinal Procedural Solution making integration a very simple proposition. An additional module containing all of the necessary attachments is required for utilizing the FluoroNav® MAST™ Spinal Procedural Solution.

The primary benefit of using the FluoroNav® MAST™ Spinal Procedural Solution is that a virtual extension of the instruments will demonstrate the accuracy of any proposed pedicle trajectory. The proper trajectory can be determined prior to navigating the pedicle. The FluoroNav® MAST™ Spinal Procedural Solution also provides the ability to see multiple views simultaneously without increasing radiation exposure.



Figure 7A

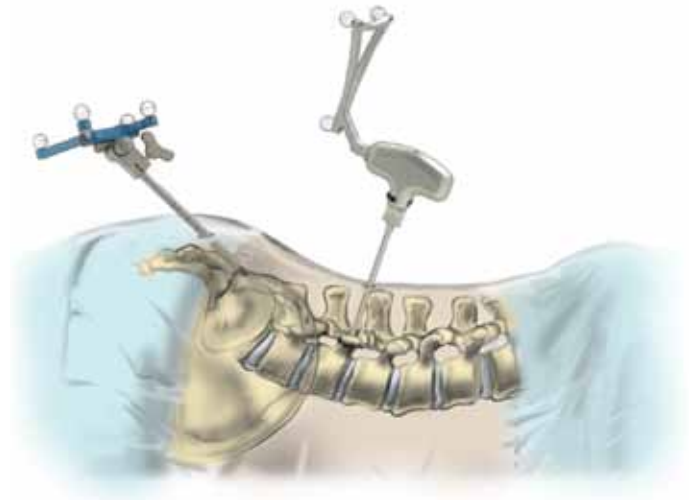

Figure 7B

## STEP 5 | Accessing the Pedicle

### PAK Needle Insertion

A PAK (Pedicle Access Kit) Needle is used to gain access to the pedicle. After placing the PAK Needle at the intersection of the facet and the transverse process, the needle is advanced (Figure 8).

An AP image should show the needle tip at the lateral margin of the pedicle initially. As the needle advances toward the base of the pedicle on the lateral image, it should approach the pedicle center on the AP image (Figures 9A and 9B).



Figure 8



Figure 9A



Figure 9B



Tip

*The PAK Needle should be advanced across the junction of the pedicle and the vertebral body to allow easier placement of the Guidewire.*

*Care should be taken so the needle is not too medial. This avoids breaching the medial wall when tapping or inserting the Screw.*

For neuromonitoring, a NIM PAK Needle may be used to access the pedicle. Triggered EMG monitoring can be performed during advancement of the needle into the pedicle to ensure proper placement.



## STEP 6 | Guidewire Insertion

The inner stylet of the needle is removed to allow the Guidewire to be inserted into the pedicle (**Figures 10 and 11**). Be extremely careful with regard to the position of the Guidewire. Unintentional advancement of the wire can potentially be very dangerous. Once the Guidewire is inserted, the needle may be removed.

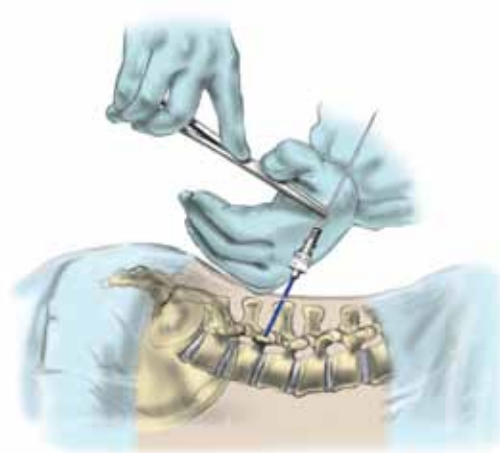

Figure 10

### ✓ Tip

*"I recommend placing the Guidewire 60% to 70% into the vertebral body for a 'safe zone' of bony anatomy during pedicle preparation and screw insertion. This tactic allows for space if the Guidewire advances inadvertently."*

—Najeeb Thomas, MD



Figure 11

## STEP 7 | Dilating the Fascia

The fascia and muscle must be dilated to allow for screw placement. Three Dilators are used to gently make a path of the appropriate dimension (**Figure 12**). The first two Dilators are removed, leaving the third Dilator to serve as a tissue protection sleeve during the tapping step.

When using the NIM-ECLIPSE® Spinal System, a blue Large Disposable Dilator should be used for dilating and tapping purposes. After dilating, the Large Disposable Dilator remains in place and serves as an insulator during the tapping step.



Figure 12

✓ Tip

*Incise the skin to allow for dilation of the Large Dilator—approximately 15mm.*

*Dilators should dock on bony anatomy to minimize tissue creepage.*

## STEP 8 | Pedicle Preparation

The pedicle is prepared by placing the Tap over the Guidewire and through the third dilation sleeve (**Figure 13A**). In dense bone, where the Screw may be difficult to advance, ensure that the pedicle is fully prepared by using a Tap the same size as the Screw to be inserted.

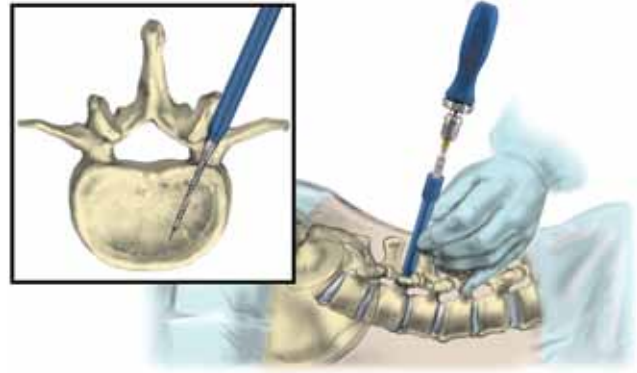

Figure 13A

### ✓ Note

*It is important to keep the Tap along the same axis as the Guidewire. If a change in trajectory is required, the PAK Needle should be reinserted over the Guidewire, the Guidewire removed, and the inner stylet replaced.*

### ✓ Tip

*Use the Self-Drilling Tap option if particularly hard bone is encountered.*

*If using the NIM-ECLIPSE® Spinal System during this procedure, the Large Disposable Dilator (8675424) must be used.*

Further evaluation of the tapped pedicle can be performed by using the NIM-ECLIPSE® Spinal System Surgeon-directed Ball-tip Probe to stimulate the Tap (9450097). Free-running EMG will monitor any nerve root irritation during this procedure (**Figures 13B and 13C**).



Figure 13B



Figure 13C

## STEP 8 | Pedicle Preparation *continued*

Screw length can be estimated by referencing the depth marks on the Tap with the rim of the Large Dilator (Figure 14).

### ✓ Tip

*If you tap beyond the tip of the Guidewire, bone within the end of the Tap may cause the Guidewire to pull out as you remove the Tap. To avoid this, advance the Guidewire through the Tap before you remove the Tap from the vertebral body.*

*If the Guidewire becomes bent, place a PAK Cannula over the bent Guidewire then replace it with a new (straight) Guidewire.*

Fluoroscopy should be used to verify the position of the Guidewire and the Tap during this step (Figure 15). After tapping, remove the Dilator but leave the Guidewire in place.



Figure 14



Figure 15



## STEP 9 | Extender Sleeve and Screw Assembly

To insert two Screws, use the **silver** One-Level Extenders: One-Level Extender A (75753039) and One-Level Extender B (75753049) (**Figure 16**).



Figure 16

## STEP 9 | Extender Sleeve and Screw Assembly *continued*

Before a Screw can be inserted into the pedicle, the Screw Extenders must be assembled with the Multi-Axial Screws. To assemble the Screw Extender, insert the Inner Sleeve into the Extender. Squeeze the flexible tabs of the Inner Sleeve together and insert into the Extender (**Figure 17A**).

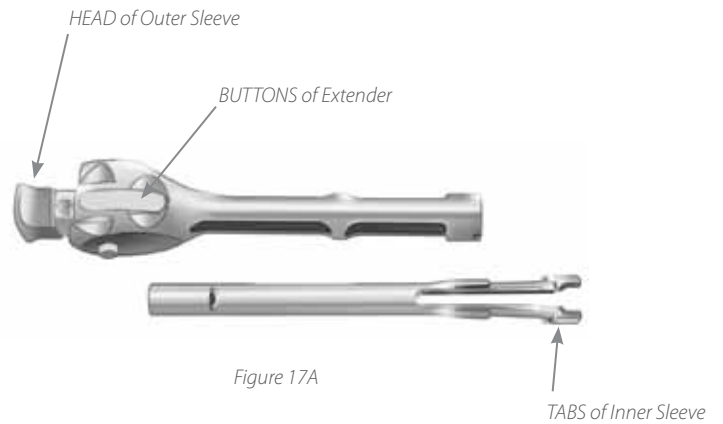

✓ Tip

To ensure easier loading of the assembly, keep the head of the Extender in the Open position.

While assembling these components, the arrow on the Inner Sleeve should be visible through the window of the Extender (**Figure 17B**).

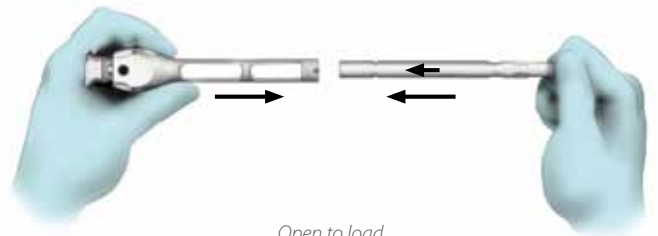

To load a Screw, the Inner Sleeve must be in the downward position: the shelf on the Inner Sleeve should be flush with the ledge of the Extender so that the tabs of the Inner Sleeve are open to capture the Screw (**Figure 17C**).

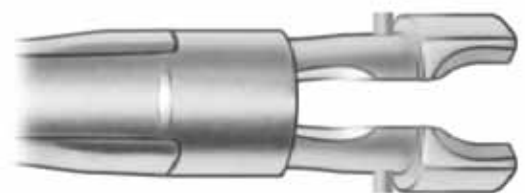

## STEP 9 | Extender Sleeve and Screw Assembly *continued*

With the distal tabs of the Inner Sleeve in the open position, place the Screw into the Inner Sleeves (**Figure 18**).

Once the Screw is seated in the tabs, push the Screw and Inner Sleeve into the Extender. Push the head of the Extender down and push the Inner Sleeve with the Screw into the Extender to lock the assembly (**Figures 19 and 20**). To verify the assembly is connected properly, pull on the Screw.

To change Screw sizes once the Extenders have been assembled, reverse the assembly steps by pushing the buttons on the top of the Extender and pulling the head up. The Inner Sleeve is now unlocked and can slide down to open the tabs.



*Open to load  
Figure 18*



*Figure 19*



*Closed and secure  
Figure 20*



**Tip**

*Grip the shaft of the Extender assembly to keep the Inner Sleeve in the lowest position so the tabs remain open.*

## STEP 10 | Screw Insertion

Insert the Retaining Bonescrew Driver (7570023) into the Screw Extender assembly. The tip of the driver passes into the head of the Multi-Axial Screw until the driver fully engages the Screw.

Thread the sleeve of the Retaining Driver into the head of the Screw before inserting over the Guidewire (**Figure 21**). The Cannulated Bonescrew Driver (7570021) may also be used if desired.

The entire Screw Extender assembly is inserted over the Guidewire and into the pedicle (**Figures 22 and 23**). If the Screw is difficult to advance, remove the assembly while leaving the Guidewire in place, and ensure the pedicle is fully prepared by using a Tap the same diameter as the inserted Screw. After driving the Screw assembly through the pedicle, remove the Guidewire to prevent it from being advanced. Be certain that the Screw assembly is not inserted too far. If the multi-axial head of the CD HORIZON® LEGACY™ Cannulated Screw is driven too forcefully against the bone, it will lose its multi-axial capabilities, making it difficult to connect the assemblies during subsequent steps.

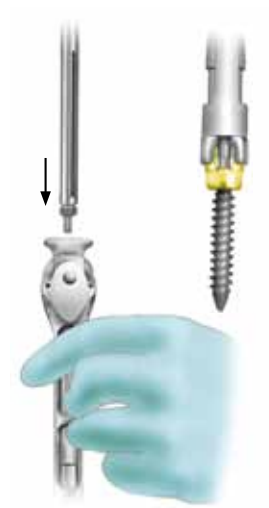

Figure 21

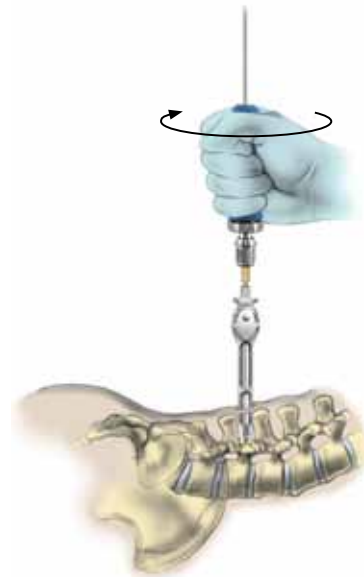

Figure 22



Tip

*If desired, the Guidewire may be removed from the pedicle once the Screw is in the vertebral body.*

*Inserting the Screw too far will cause it to lose its multi-axial capabilities and make rod insertion difficult.*



Figure 23

## STEP 11 | Second Screw Insertion

The process is repeated for additional Screws on the same side. After inserting the assemblies, the Screw Extenders should be at approximately the same height outside the patient (**Figure 24**). The assemblies should move freely following Screw insertion.

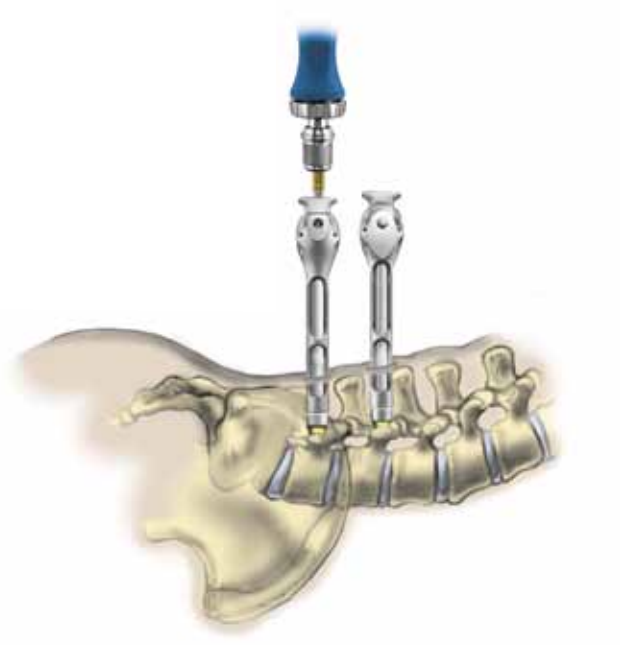

Figure 24

## STEP 12 | Connecting the Extenders

Rotate the Extenders so that the flat sides are facing each other (**Figure 25A**). The male and female parts are then mated together and rotated so there is no gap between the Extenders (**Figure 25B**). Once the Extenders are connected and the flat surfaces are completely flush, the Rod Inserter can be attached.



Tip

*Make sure there is no gap between the Extenders by looking down the head or foot of the patient.*

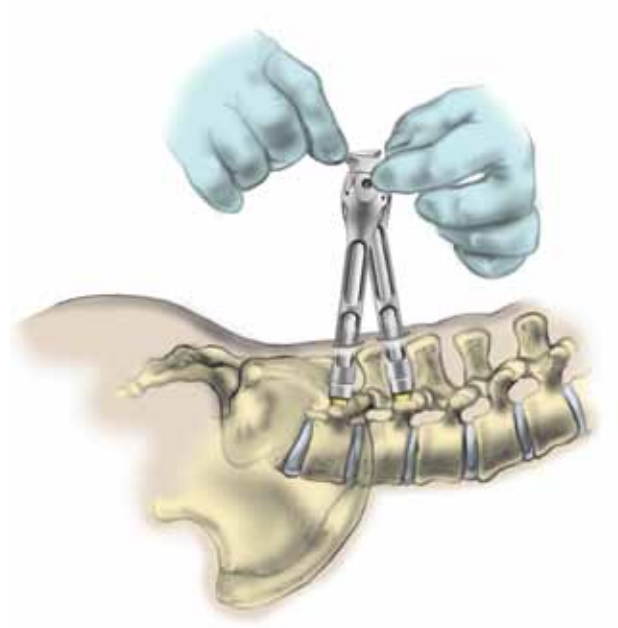

Figure 25A



Figure 25B

## STEP 13 | Attaching Rod Inserter to Screw Extenders

Before connecting the Rod Inserter to the Extenders, attach the Trocar Tip to the tip of the Rod Inserter by lifting the latch on the top of the Rod Inserter. This will allow the Rod Inserter to receive the Tip. Insert the Trocar Tip into the collet and return the latch to the original position to secure the Tip (**Figure 26**). Pull on the Trocar Tip to ensure a secure fit.

Open the latch on the side of the Rod Inserter to connect to the Extenders (**Figure 27A**). Return to the LOCKED position once the Extenders fit securely in the arc (**Figures 27B and 27C**).

Please see the next page for important details regarding the assembly of the Rod Inserters to the Screw Extender assembly.

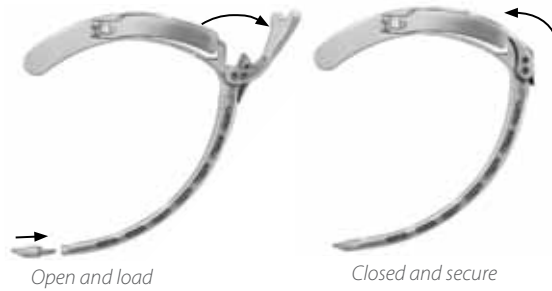
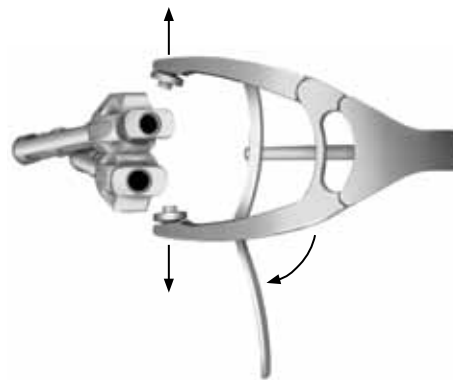
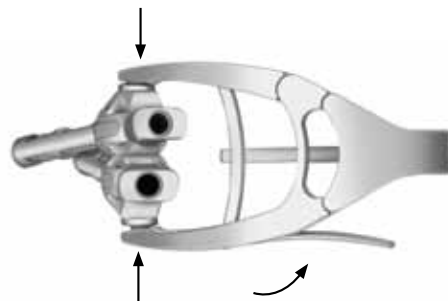

Figure 26



Open and load  
Figure 27A



Closed and secure  
Figure 27B



Figure 27C

STEP 13 | Attaching Rod Inserter to Screw Extenders *continued*

## ✓ Tip

The following steps should be taken to ensure that the Inserter is properly attached to the Extender assemblies:

1. Push one side of the Inserter arm onto the Extender with thumb.
2. Hold and squeeze the other side of the Inserter to engage the other Extender.
3. Lock assembly with lever arm.

The Inserter should now be flush with both sides of the mated Extender assemblies. These steps will ensure accurate rod passage through the Screw heads.



Step 1



Step 2



Step 3



## STEP 14 | Passing the Trocar

The Trocar Tip is used to help make a path through the fascia and muscle down to the saddle of the first Screw (Figure 28). A small skin incision is required and then the Trocar Tip is advanced through the muscle until it hits the first Screw saddle (Figure 29). The Trocar Tip position should be confirmed by lateral fluoroscopy.

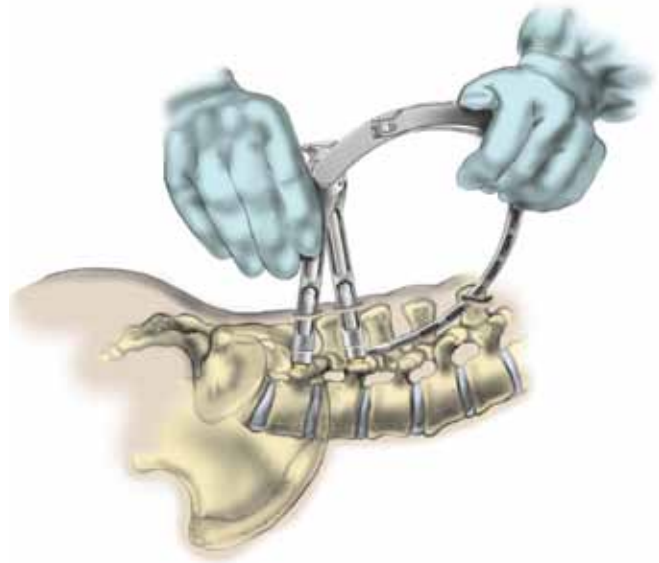

Figure 28

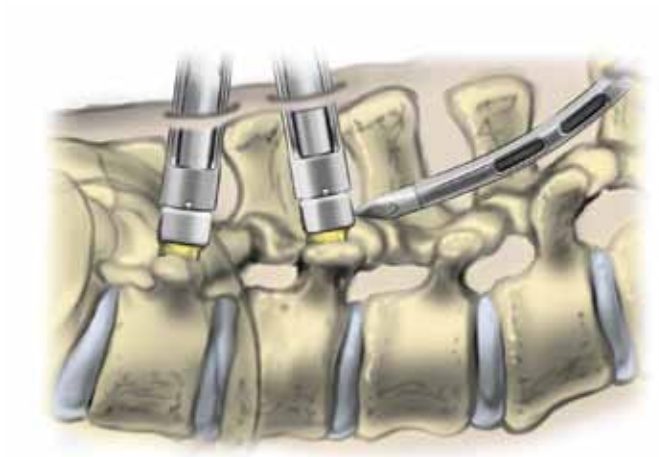

Figure 29

## STEP 15 | Measuring the Rod

To determine the appropriate Rod length, place the Rod Templates into the cephalad and caudal Screw Extenders. Place the Rod Template Pointer toward the Stationary Rod Template to determine the measurement (**Figure 30**).

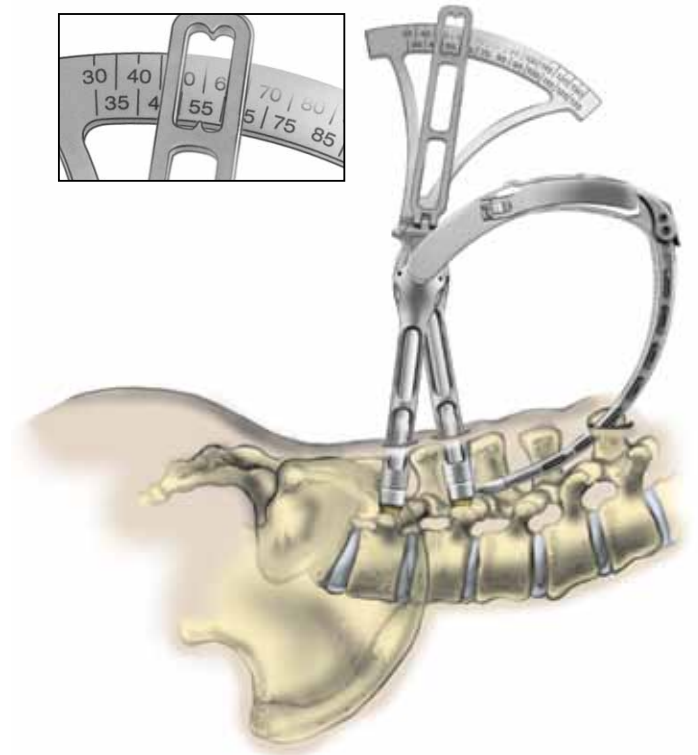

Figure 30

## STEP 16 | Passing the Rod

Replace the Trocar Tip with the appropriately sized Rod as determined by the Rod Template. Remove the Trocar Tip by lifting the Rod attachment lever to open the rod collet. Insert the Rod and return the lever to the locked position (**Figure 31**). Pass the Rod through the Screw heads so that the tapered tip of the Rod is through the distal Screw (**Figures 32A and 32B**).

### Tip

Ensure that the Rod is fully seated in the Rod Inserter by pushing the Rod firmly into the tip.

Pull on the Rod to ensure a secure fit.

Confirm alignment of the Rod with the axis of the arc by sighting both the side and top-down views.

To confirm that the Rod is through all Screw heads, use any of the Bonescrew Drivers for visual verification. Drop the Driver down the shaft of an Extender. If the black line on the Driver is visible above the Extender, the Rod has passed through the Screw (**Figure 32C**). Confirmation can also be made with fluoroscopy.

### Tip

If there is difficulty passing the Rod through the second Screw, the Rod Inserter may be released from the Extenders for a "freehand" technique to pass the Rod. The Extenders must be held together manually if this technique is used.

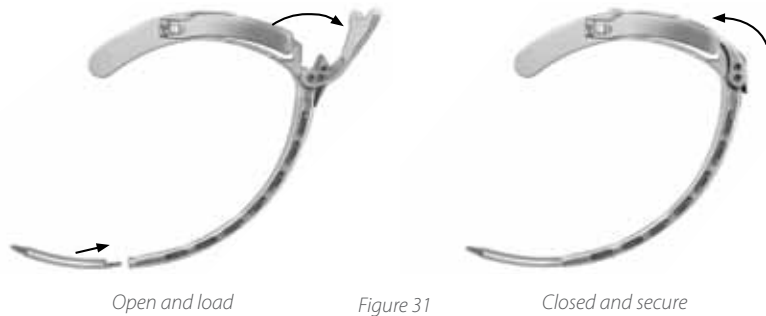

Figure 31

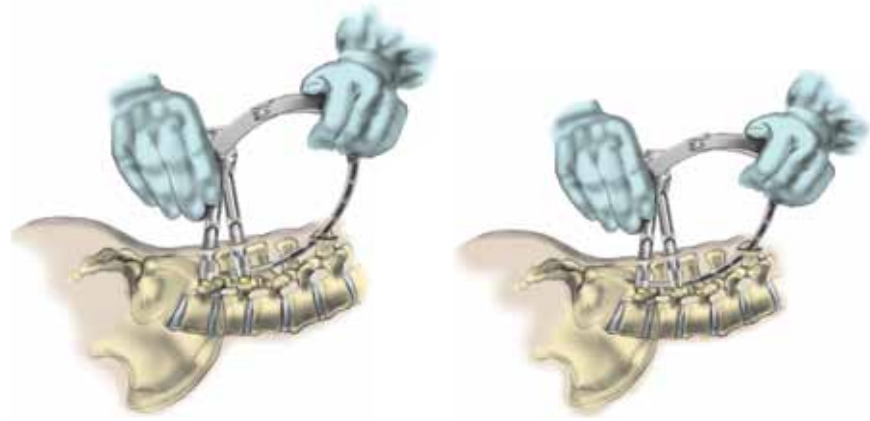

Figure 32A

Figure 32B

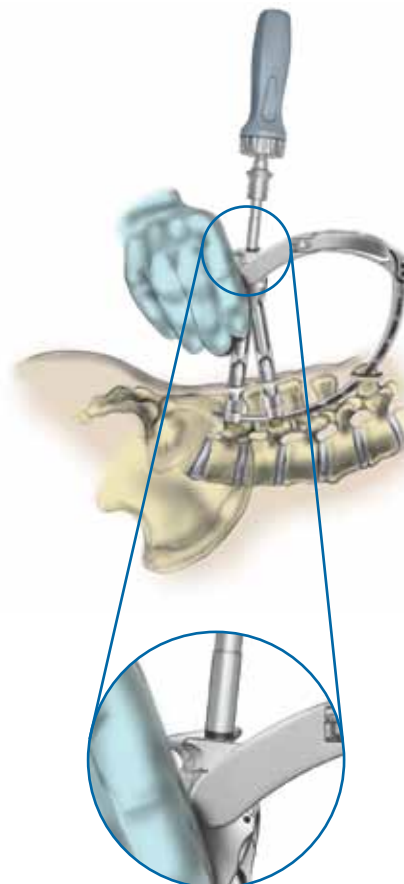

Figure 32C

## STEP 17 | Set Screw Insertion and Final Break-off

After verifying that the Rod is seated in all the Screws, the Set Screws can be inserted with the Set Screw Retaining Compressors (7570095).

The Compressors act as:

- Compressors or Distractors
- Self-retaining Break-off Driver

Begin by loading the Set Screw on the tip of the Compressor. Push the button on the Compressor handle (**Figure 33**). While pushing the button, insert the Set Screw on the distal tip of the Compressor (**Figures 34A and 34B**). Release the button and tug on the Set Screw to ensure a secure connection.



Figure 33

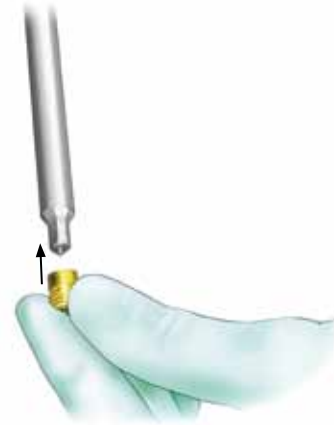

Figure 34A



Figure 34B



Tip

*The button on the Compressor handle should be proud once the Set Screw is loaded.*

## STEP 17 | Set Screw Insertion and Final Break-off *continued*

Insert the Compressor and Set Screw assembly down the Extender shaft and thread the Set Screw into the saddle of the Screw to engage the Rod (Figure 35).

### Compression or Distraction

Provisionally tighten one of the Set Screws. To compress, squeeze the two Compressors together and lock down the final Set Screw (Figure 36). To distract, pull the two handles apart and lock down the Set Screw (Figure 37).

#### ✓ Tip

The Break-off Handle can also assist in provisionally tightening the Set Screw.



Figure 35

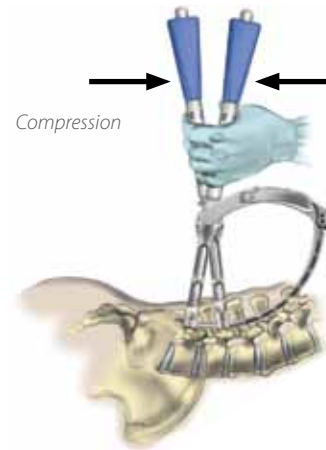

Figure 36

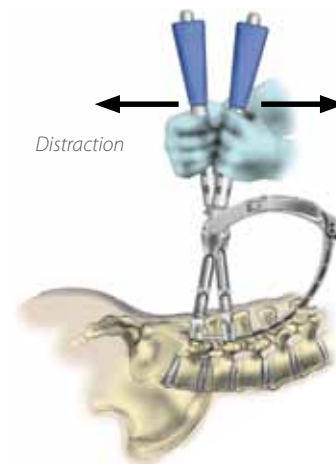

Figure 37

## STEP 17 | Set Screw Insertion and Final Break-off *continued*

The Rod Inserter assembly serves as the counter-torque device during final break-off.

The Break-off Handle should be used for the final break-off and to help provisionally tighten the Set Screw (**Figure 38**). The Compressor retains the sheared-off portion of the Set Screw.

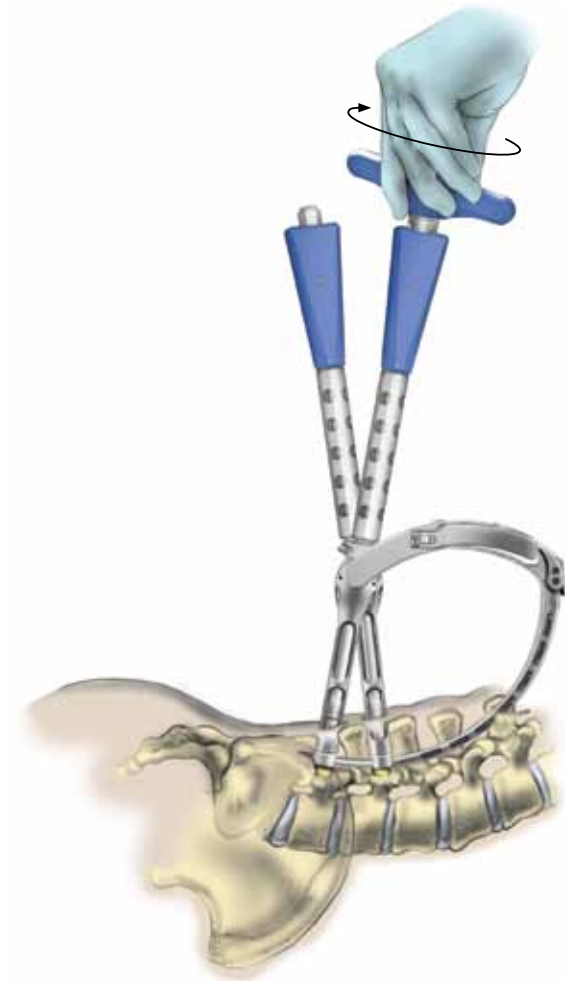

Figure 38

### ✓ Tip

*Do not push the button on the top of the Compressor handle until it is completely removed from the Extender shaft as this will release the Set Screw prematurely.*

## STEP 18 | Removing Assembly

The Rod Inserter must be detached from the Rod by reversing the steps of attachment. Lift the lever to release the Rod and swing the arm up to remove from the patient (**Figure 39A**). To detach the Inserter from the Extenders, open the Inserter with the side lever (**Figure 39B**).

Remove the Extenders from the Screws by depressing buttons on the Extender and lifting the head of the Extender (**Figure 40**). Remove from the Screw heads by pulling the Extender assemblies out individually.

The final construct can be verified with AP and lateral fluoroscopy.



Open and unload

Figure 39A

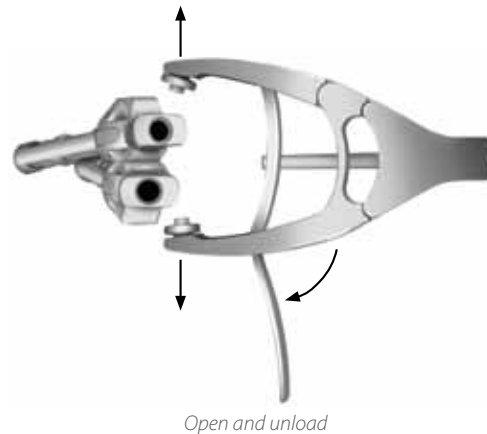

Open and unload

Figure 39B



Tip

*Gentle side-to-side rocking may assist in removal of the Extenders.*

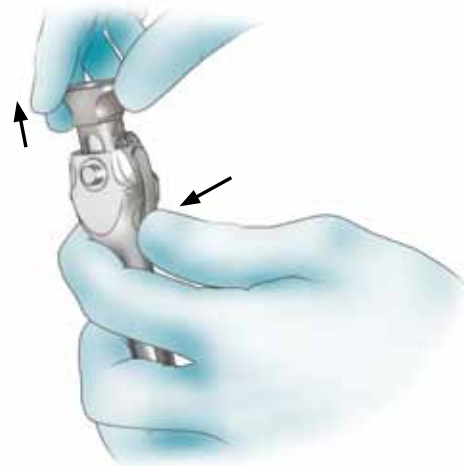

Figure 40

## STEP 19 | Closure, Graft Placement and Explantation

The entire process is repeated on the contralateral side. Closure is accomplished with a few interrupted stitches in the fascia, a subcuticular skin suture, and Steri-Strips™ (Figure 41).

### Bone Graft Placement

Bone graft must be used when implanting the construct (Figure 42).

### Implant Explantation

The CD HORIZON® LEGACY™ Cannulated Multi-Axial Screw, Set Screws and Rods may be removed by applying the T27 Removal Driver to the Set Screw and turning counterclockwise until the Set Screw is removed. The CD HORIZON® LEGACY™ Cannulated Multi-Axial Screws may be removed by applying the Cannulated Retaining Bonescrew Driver from the CD HORIZON® SEXTANT® II Instrument Set to the Screw and turning counterclockwise until the Screw is removed from the pedicle.



Figure 41



Figure 42



# CD HORIZON® SEXTANT® II

Rod Insertion System

---

Two-Level  
Surgical Steps

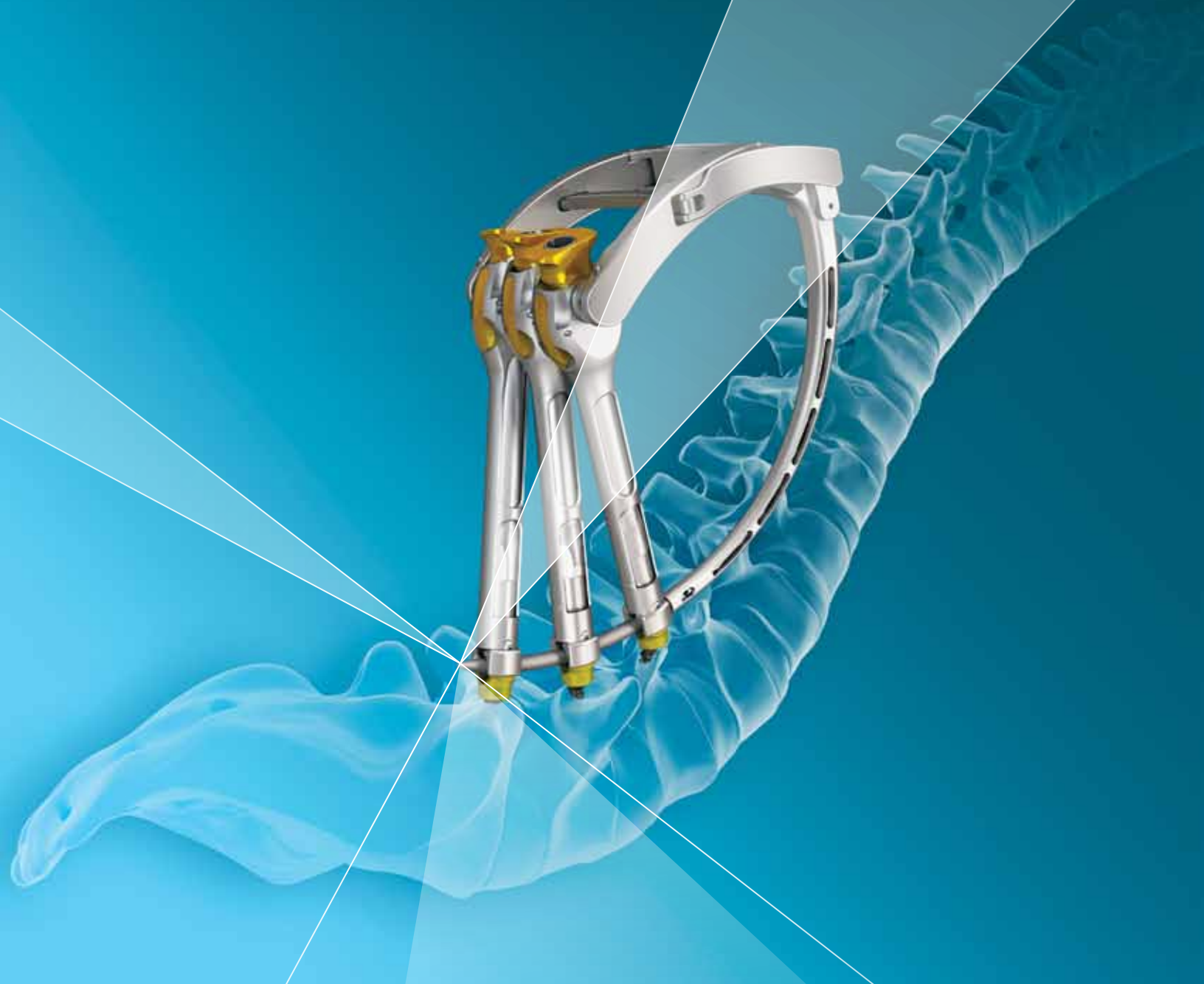

## STEP 5 | Accessing the Pedicle

### PAK Needle Insertion

A PAK (Pedicle Access Kit) Needle is used to gain access to the pedicle. After placing the PAK Needle at the intersection of the facet and the transverse process, the Needle may be advanced partially through the pedicle (**Figure 43**).

An AP image should show the Needle tip at the lateral margin of the pedicle initially. As the needle advances towards the base of the pedicle on the lateral image, it should approach the pedicle center on the AP image (**Figures 44A and 44B**).

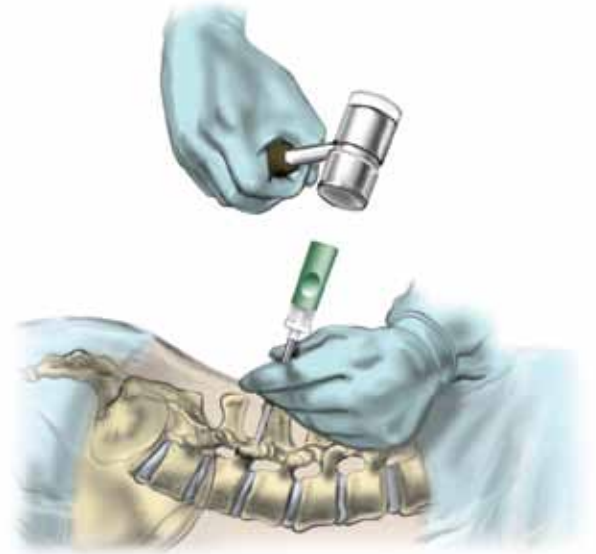

Figure 43



Tip

*The PAK Needle should be advanced across the junction of the pedicle and the vertebral body to allow easier placement of the Guidewire.*

*Care should be taken so the Needle is not placed too medial. This avoids breaching the medial pedicle wall when tapping or inserting the Screw.*



Figure 44A



Figure 44B

For neuromonitoring, a NIM PAK Needle may be used to access the pedicle. Triggered EMG monitoring can be performed during advancement of the needle into the pedicle to ensure proper placement.



## STEP 5 | Accessing the Pedicle *continued*

### Freehand Method

Either oblique or AP fluoroscopy should be used to insert PAK Needles in all three pedicles so that the skin insertion and pedicle insertion points are aligned in the axial plane. Drawing a line on the skin prior to insertion can facilitate this (**Figure 45**).

Insert the Guidewire as with single-level procedures by removing the PAK handle and inner stylet. Remove the PAK Cannula and dilate over the Guidewire as with the one-level technique.

### Alignment Guide Method

Prepare pedicles at the most caudal and cephalad levels in the same manner described previously (**Figure 46**). Proceed to page 36 for insertion of middle PAK Needle, Guidewire and Screw Extenders.



Figure 45

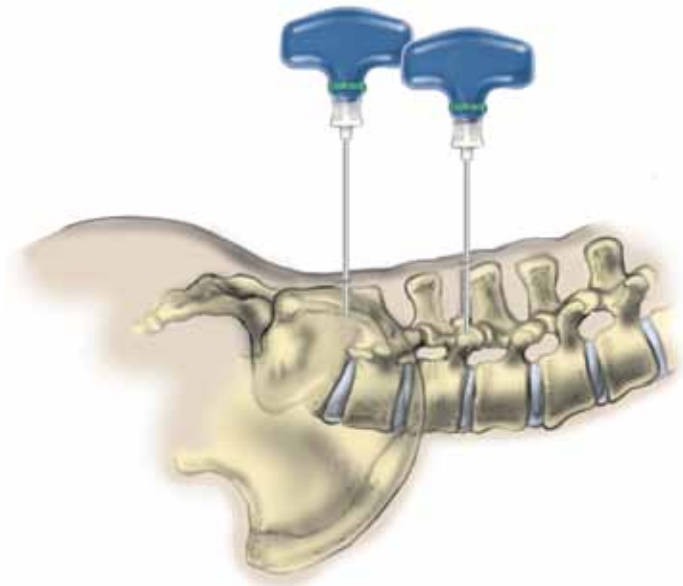

Figure 46

## STEP 6 | Screw Extender Assembly

To insert three screws, use the gold Two-Level Extenders: two Two-Level Outer Extenders (75753019) and one Two-Level Middle Extender (75753029) (Figures 47 and 48).

 Note

*For a multilevel procedure, the Screw Extenders labeled Outer Extenders (75753019) should be used at the cephalad or caudal pedicles.*



Figure 47



Figure 48

## STEP 7 | Screw Insertion

### Freehand Method

After tapping through the large Dilator, insert the Screw Extender assemblies over the Guidewire into the pedicle, similar to the one-level technique (**Figure 49**).

Insert all Screw Extender assemblies into the pedicles, using the Outer Extenders for the most caudal and cephalad levels, and the Middle Extender for the middle level (**Figure 50**). Proceed to page 38 to attach the Rod Inserter.

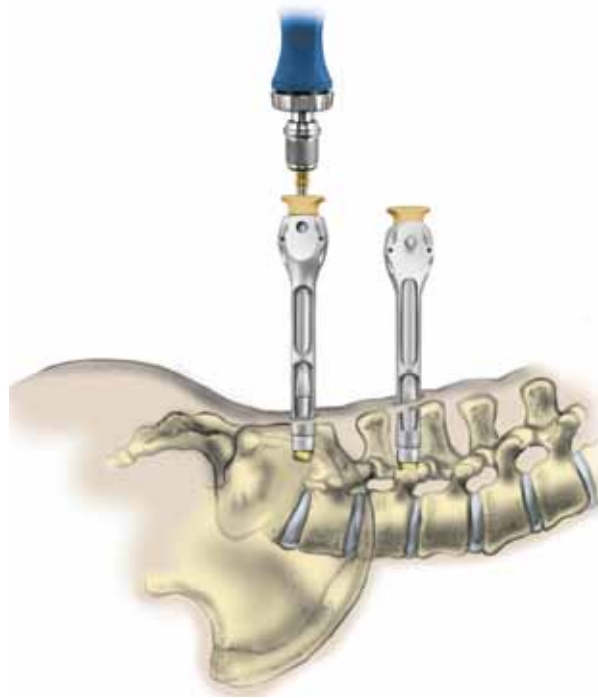

Figure 49

#### ✓ Note

*Remember, when using the alignment guide technique, the cephalad and caudal Screws will be inserted before placement of the middle Guidewire. The Alignment Guide Technique is described on pages 36 – 37.*

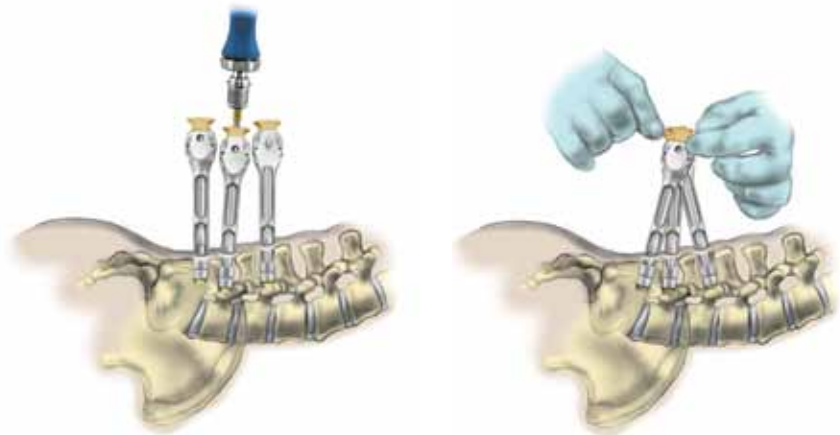

Figure 50

## STEP 7 | Screw Insertion *continued*

### Alignment Guide Method

Insert Screws connected to the Outer Screw Extenders at the most caudal and cephalad levels (**Figure 51A**). Connect the Alignment Guide to the Outer Screw Extenders and attach the Extender Clamp (**Figures 51B and 51C**).

Insert the X-PAK Needle through the Alignment Guide and target the middle pedicle using fluoroscopy, NIM, or a navigation system (**Figure 52**). Advance the X-PAK Needle to the desired position, then insert the Guidewire through the X-PAK Needle into the pedicle.

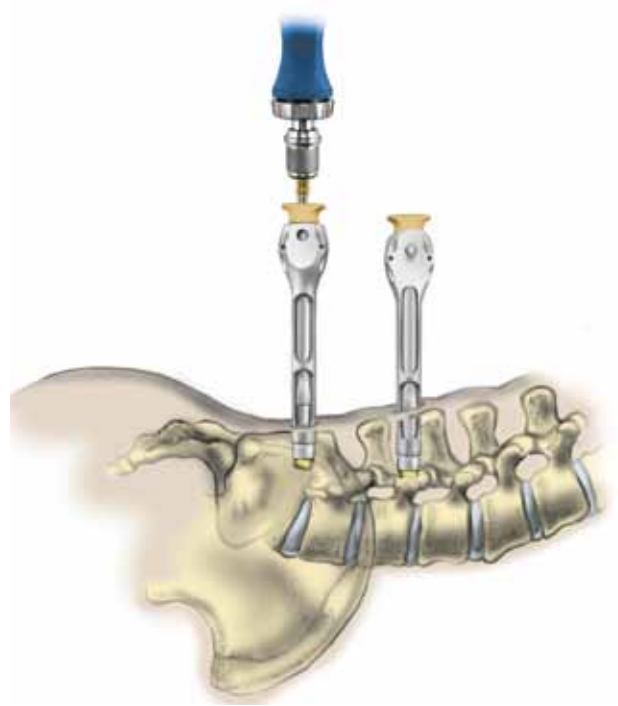

Figure 51A



Figure 51B

Figure 51C



Figure 52

## STEP 8 | Connecting the Extenders

### Alignment Guide Method *continued*

Disconnect and remove the Extender Clamp and Alignment Guide. Also remove the X-PAK Needle, leaving the Guidewire in place (**Figures 53A and 53B**). Dilate and tap over the Guidewire. Assemble the Inner Screw Extender with the appropriate size Screw and insert over the Guidewire into place (**Figure 54A**).

Rotate the Extenders so that the flat sides are facing each other (**Figure 54B**). The male and female parts are then mated together and rotated so there is no gap between the Extenders. Once the Extenders are connected and the flat surfaces are completely flush, the Rod Inserter can be attached.



Figure 53A

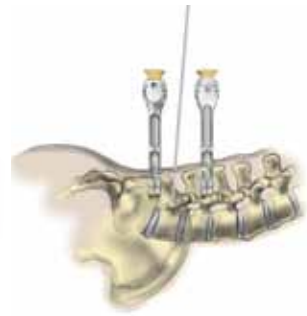

Figure 53B

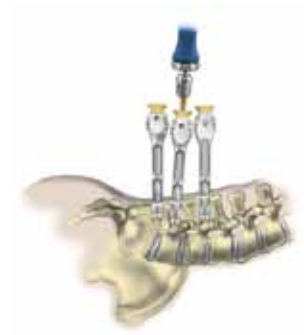

Figure 54A



Figure 54B

## STEP 9 | Attaching Rod Inserter to Screw Extenders

Before connecting the Rod Inserter to the Extenders, attach the Trocar Tip into the end of the Rod Inserter by lifting the latch on the top of the Rod Inserter. This will allow the Rod Inserter to receive the Trocar Tip. Insert the Trocar Tip into the collet and return the latch to the original position to secure the tip (**Figures 55A and 55B**). Pull firmly on the Trocar Tip to ensure a secure fit.

Open the latch on the side of the Inserter to connect to the Extenders (**Figure 56A**). Return to the LOCKED position once the Extenders fit securely on the arc (**Figures 56B and 57**).

Please see the next page for important details regarding the assembly of the Rod Inserter to the Screw Extender assembly.



Open and load

Figure 55A



Closed and secure

Figure 55B

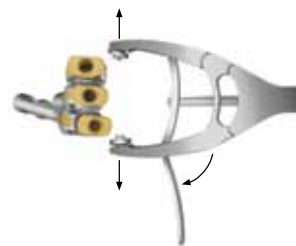

Figure 56A

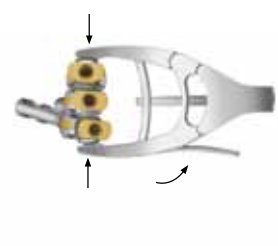

Figure 56B



Figure 57



## STEP 9 | Attaching Rod Inserter to Screw Extenders *continued*

### ✓ Tip

The following steps should be taken to ensure that the Inserter is properly attached to the Extender assemblies:

1. Push one side of the Inserter arm onto the Extender with thumb.
2. Hold and squeeze the other side of the Inserter to engage the other Extender.
3. Lock assembly with lever arm.

The Inserter should now be flush with both sides of the mated Extender assemblies. These steps will ensure accurate rod passage through the screw heads.



Step 1



Step 2



Step 3

## STEP 10 | Passing the Rod

Replace the Trocar Tip with the appropriately sized Rod as determined by the rod template. Remove the Trocar by lifting the Rod attachment lever to open the rod collet. Insert the Rod and return the lever to the locked position (**Figure 58**). Pass the Rod through the screw heads so that the tapered tip of the Rod is through the distal Screw.

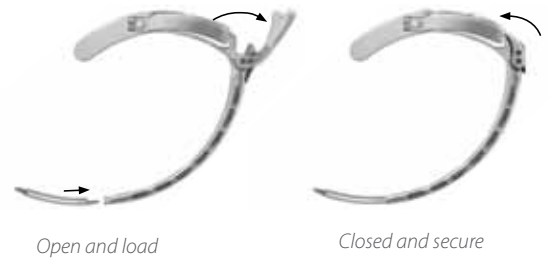

Figure 58

### ✓ Tip

Ensure that the Rod is fully seated in the Rod Inserter by pushing the Rod firmly into the tip.

Ensure alignment of the Rod with the axis of the arc by sighting on the convex side of the arc.

To confirm that the Rod is through all screw heads, use any of the Bonescrew Drivers for visual verification. Drop the Driver down the shaft of an Extender. If the black line on the Driver is visible above the Extender, the Rod has passed through the Screw (**Figure 59**). Confirmation can also be made with fluoroscopy.

### ✓ Tip

If there is difficulty passing the Rod through the second Screw, the Rod Inserter may be released from the Extenders for a “freehand” technique to pass the Rod. The Extenders must be held together manually if this technique is used.

Once the Rod has been passed, insert the Set Screws as described on page 26 and follow subsequent steps to complete the procedure.

Please see notes on bone graft placement and implant explantation on page 30.

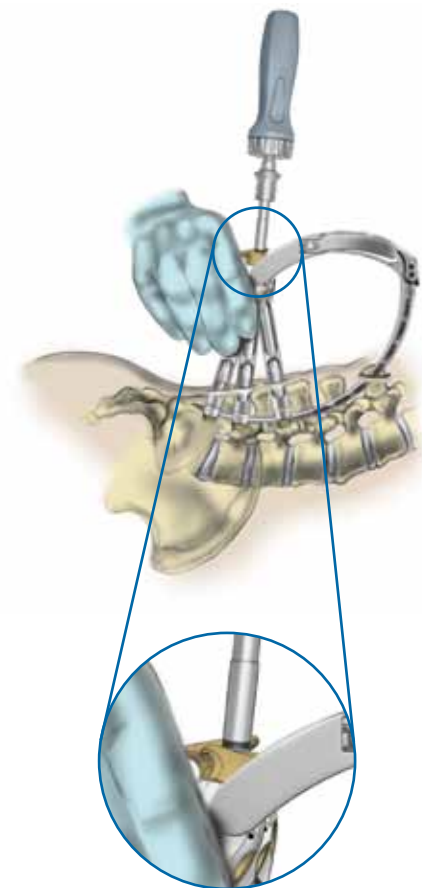

Figure 59

# Important Information on the CD HORIZON® Spinal System

## PURPOSE

The CD HORIZON® Spinal System is intended to help provide immobilization and stabilization of spinal segments as an adjunct to fusion of the thoracic, lumbar, and/or sacral spine.

## DESCRIPTION

The CD HORIZON® Spinal System consists of a variety of shapes and sizes of rods, hooks, screws, CROSSLINK® Plates, staples and connecting components, as well as implant components from other Medtronic spinal systems, which can be rigidly locked into a variety of configurations, with each construct being tailor-made for the individual case.

Certain implant components from other Medtronic spinal systems can be used with the CD HORIZON® Spinal System. These components include TSRH® rods, hooks, screws, plates, CROSSLINK® plates, connectors, staples and washer, GDLH® rods, hooks, connectors and CROSSLINK® bar and connectors; LIBERTY® rods and screws; DYNALOK® PLUS and DYNALOK CLASSIC® bolts along with rod/bolt connectors; and Medtronic Multi-Axial rods and screws. Please note that certain components are specifically designed to connect to  $\phi$ 3.5mm,  $\phi$ 4.5mm,  $\phi$ 5.5mm rods or  $\phi$ 6.35mm rods, while other components can connect to both  $\phi$ 5.5mm rods and  $\phi$ 6.35mm rods. Care should be taken so that the correct components are used in the spinal construct.

CD HORIZON® hooks are intended for posterior use only. CD HORIZON® staples and CD HORIZON® ECLIPSE® rods and associated screws are intended for anterior use only. However, for patients of smaller stature, CD HORIZON® 4.5mm rods and associated components may be used posteriorly.

The CD HORIZON® Spinal System implant components are fabricated from medical grade stainless steel, medical grade titanium, titanium alloy, medical grade cobalt-chromium-molybdenum alloy, or medical grade PEEK OPTIMA-LT1. Certain CD HORIZON® Spinal System components may be coated with hydroxyapatite. No warranties express, or implied, are made. Implied warranties of merchantability and fitness for a particular purpose or use are specifically excluded. See the MDT Catalog for further information about warranties and limitations of liability.

### Never use stainless steel and titanium implant components in the same construct.

Medical grade titanium, titanium alloy and/or medical grade cobalt-chromium-molybdenum alloy may be used together. Never use titanium, titanium alloy and/or medical grade cobalt-chromium-molybdenum alloy with stainless steel in the same construct.

The CD HORIZON® Spinal System also includes anterior staples made of Shape Memory Alloy (Nitinol – NiTi). Shape Memory Alloy is compatible with titanium, titanium alloy and cobalt-chromium-molybdenum alloy. Do not use with stainless steel.

PEEK OPTIMA-LT1 implants may be used with stainless steel, titanium or cobalt-chromium-molybdenum alloy implants. **CD HORIZON® PEEK Rods are not to be used with CROSSLINK® Plates.**

To achieve best results, do not use any of the CD HORIZON® Spinal System implant components with components from any other system or manufacturer unless specifically allowed to do so in this or another Medtronic document. As with all orthopaedic and neurosurgical implants, none of the CD HORIZON® Spinal System components should ever be reused under any circumstances.

## INDICATIONS

The CD HORIZON® Spinal System with or without SEXTANT® instrumentation is intended for posterior, non-cervical fixation as an adjunct to fusion for the following indications: degenerative disc disease (defined as back pain of discogenic origin with degeneration of the disc confirmed by history and radiographic studies); spondylolisthesis; trauma (i.e., fracture or dislocation); spinal stenosis; curvatures (i.e., scoliosis, kyphosis and/or lordosis); tumor; pseudarthrosis; and/or failed previous fusion.

Except for hooks, when used as an anterolateral thoracic/lumbar system, the CD HORIZON® Spinal System may also be used for the same indications as an adjunct to fusion.

With the exception of degenerative disc disease, the CD HORIZON® LEGACY™ 3.5mm rods and the CD HORIZON® Spinal System PEEK rods and associated components may be used for the aforementioned indications in skeletally mature patients as an adjunct to fusion.

The CD HORIZON SPIRE™ Plate is a posterior, single level, non-pedicle supplemental fixation device intended for use in the non-cervical spine (T1-S1) as an adjunct to fusion. It is intended for plate fixation/attachment to spinous processes for the purpose of achieving supplemental fusion in the following conditions: degenerative disc disease (as previously defined); spondylolisthesis, trauma; and/or tumor.

In order to achieve additional levels of fixation as an adjunct to fusion, the CD HORIZON® Spinal System rods may be connected to the VERTEX® Reconstruction System with the VERTEX® rod connector. Refer to the VERTEX® Reconstruction System Package Insert for a list of the VERTEX® indications of use.

## CONTRAINDICATIONS

Contraindications include, but are not limited to:

1. Active infectious process or significant risk of infection (immunocompromise).
2. Signs of local inflammation.
3. Fever or leukocytosis.

4. Morbid obesity.
5. Pregnancy.
6. Mental illness.
7. Grossly distorted anatomy caused by congenital abnormalities.
8. Any other medical or surgical condition which would preclude the potential benefit of spinal implant surgery, such as the presence of congenital abnormalities, elevation of sedimentation rate unexplained by other diseases, elevation of white blood count (WBC), or a marked left shift in the WBC differential count.
9. Suspected or documented metal allergy or intolerance.
10. Any case not needing a bone graft and fusion.
11. Any case where the implant components selected for use would be too large or too small to achieve a successful result.
12. Any patient having inadequate tissue coverage over the operative site or inadequate bone stock or quality.
13. Any patient in which implant utilization would interfere with anatomical structures or expected physiological performance.
14. Any patient unwilling to follow postoperative instructions.
15. Any case not described in the indications.

**NOTA BENE: Although not absolute contraindications, conditions to be considered as potential factors for not using this device include:**

1. Severe bone resorption.
2. Osteomalacia.
3. Severe osteoporosis.

## POTENTIAL ADVERSE EVENTS

All of the possible adverse events associated with spinal fusion surgery without instrumentation are possible. With instrumentation, a listing of potential adverse events includes, but is not limited to:

1. Early or late loosening of any or all of the components.
2. Disassembly, bending, and/or breakage of any or all of the components.
3. Foreign body (allergic) reaction to implants, debris, corrosion products (from crevice, fretting, and/or general corrosion), including metallosis, staining, tumor formation, and/or autoimmune disease.
4. Pressure on the skin from component parts in patients with inadequate tissue coverage over the implant possibly causing skin penetration, irritation, fibrosis, necrosis, and/or pain. Bursitis. Tissue or nerve damage caused by improper positioning and placement of implants or instruments.
5. Post-operative change in spinal curvature, loss of correction, height, and/or reduction.
6. Infection.
7. Dural tears, pseudomeningocele, fistula, persistent CSF leakage, meningitis.
8. Loss of neurological function (e.g., sensory and/or motor), including paralysis (complete or incomplete), dysesthesias, hyperesthesia, anesthesia, paresthesia, appearance of radiculopathy, and/or the development or continuation of pain, numbness, neuroma, spasms, sensory loss, tingling sensation, and/or visual deficits.
9. Cauda equina syndrome, neuropathy, neurological deficits (transient or permanent), paraplegia, paraparesis, reflex deficits, irritation, arachnoiditis, and/or muscle loss.
10. Urinary retention or loss of bladder control or other types of urological system compromise.
11. Scar formation possibly causing neurological compromise or compression around nerves and/or pain.
12. Fracture, microfracture, resorption, damage, or penetration of any spinal bone (including the sacrum, pedicles, and/or vertebral body) and/or bone graft or bone graft harvest site at, above, and/or below the level of surgery. Retropulsed graft.
13. Herniated nucleus pulposus, disc disruption or degeneration at, above, or below the level of surgery.
14. Non-union (or pseudarthrosis). Delayed union. Mal-union.
15. Loss of or increase in spinal mobility or function.
16. Inability to perform the activities of daily living.
17. Bone loss or decrease in bone density, possibly caused by stresses shielding.
18. Graft donor site complications including pain, fracture, or wound healing problems.
19. Ileus, gastritis, bowel obstruction or loss of bowel control or other types of gastrointestinal system compromise.
20. Hemorrhage, hematoma, occlusion, seroma, edema, hypertension, embolism, stroke, excessive bleeding, phlebitis, wound necrosis, wound dehiscence, damage to blood vessels, or other types of cardiovascular system compromise.
21. Reproductive system compromise, including sterility, loss of consortium, and sexual dysfunction.

## Important Information on the CD HORIZON® Spinal System *continued*

22. Development of respiratory problems, e.g. pulmonary embolism, atelectasis, bronchitis, pneumonia, etc.
23. Change in mental status.
24. Death.

**Note:** Additional surgery may be necessary to correct some of these potential adverse events.

### WARNING

The safety and effectiveness of pedicle screw spinal systems have been established only for spinal conditions with significant mechanical instability or deformity requiring fusion with instrumentation. These conditions are significant mechanical instability or deformity of the thoracic, lumbar, and sacral spine secondary to degenerative spondylolisthesis with objective evidence of neurologic impairment, fracture, dislocation, scoliosis, kyphosis, spinal tumor, and failed previous fusion (pseudarthrosis). The safety and effectiveness of this device for any other conditions are unknown. The implants are not prostheses.

In the absence of fusion, the instrumentation and/or one or more of its components can be expected to pull out, bend or fracture as a result of exposure to every day mechanical stresses.

### PRECAUTION

The implantation of pedicle screw spinal systems should be performed only by experienced spinal surgeons with specific training in the use of this pedicle screw spinal system because this is a technically demanding procedure presenting a risk of serious injury to the patient.

A successful result is not always achieved in every surgical case. This fact is especially true in spinal surgery where many extenuating circumstances may compromise the results. This device system is not intended to be the sole means of spinal support. Use of this product without a bone graft or in cases that develop into a non-union will not be successful. No spinal implant can withstand body loads without the support of bone. In this event, bending, loosening, disassembly and/or breakage of the device(s) will eventually occur.

Preoperative and operating procedures, including knowledge of surgical techniques, good reduction, and proper selection and placement of the implants are important considerations in the successful utilization of the system by the surgeon. Further, the proper selection and compliance of the patient will greatly affect the results. Patients who smoke have been shown to have an increased incidence of non-unions. These patients should be advised of this fact and warned of this consequence. Obese, malnourished, and/or alcohol abuse patients are also poor candidates for spine fusion. Patients with poor muscle and bone quality and/or nerve paralysis are also poor candidates for spine fusion.

**PHYSICIAN NOTE:** Although the physician is the learned intermediary between the company and the patient, the important medical information given in this document should be conveyed to the patient.

For US Audiences Only

**CAUTION: FEDERAL LAW (USA) RESTRICTS THESE DEVICES TO SALE BY OR ON THE ORDER OF A PHYSICIAN.**

Other preoperative, intraoperative, and postoperative warnings and precautions are as follows:

### IMPLANT SELECTION

The selection of the proper size, shape and design of the implant for each patient is crucial to the success of the procedure. Metallic surgical implants are subject to repeated stresses in use, and their strength is limited by the need to adapt the design to the size and shape of human bones. Unless great care is taken in patient selection, proper placement of the implant, and postoperative management to minimize stresses on the implant, such stresses may cause metal fatigue and consequent breakage, bending or loosening of the device before the healing process is complete, which may result in further injury or the need to remove the device prematurely.

### DEVICE FIXATION

In cases where a percutaneous posterior approach is used refer to the CD HORIZON® SEXTANT® surgical technique.

MEDTRONIC CD HORIZON® Spinal System instrumentation contains 3.5mm, 4.5 mm, 5.5mm and/or 6.35mm rods and implants, which are intended to be used with device specific instruments.

For self breaking plugs, always hold the assembly with the Counter Torque device. Tighten and break-off the head of the plug to leave the assembly at optimum fixation security. After the upper part of the self breaking plug has been sheared off, further re-tightening is not necessary and not recommended. The head part should not remain in the patient. AFTER THE UPPER PART OF THE SELF BREAKING PLUG HAS BEEN SHEARED OFF, RE-ADJUSTMENT IS NOT POSSIBLE UNLESS THE PLUG IS REMOVED AND REPLACED WITH A NEW ONE.

When using DTT Transverse Links, the M6 plug should be tightened to between 8 and 9 Nm (70 to 80 inch-lbs).

**CD HORIZON® PEEK Rods are not to be used with CROSSLINK® Plates.**

### PREOPERATIVE

1. Only patients that meet the criteria described in the indications should be selected.
2. Patient conditions and/or pre dispositions such as those addressed in the aforementioned contraindications should be avoided.
3. Care should be used in the handling and storage of the implant components. The implants should not be scratched or otherwise damaged. Implants and instruments should be protected during storage, especially from corrosive environments.
4. An adequate inventory of implants should be available at the time of surgery, normally a quantity in excess of what is expected to be used.
5. Since mechanical parts are involved, the surgeon should be familiar with the various components before using the equipment and should personally assemble the devices to verify that all parts and necessary instruments are present before the surgery begins. The CD HORIZON® Spinal System components (described in the DESCRIPTION section) are not to be combined with the components from another manufacturer.
6. All components and instruments should be cleaned and sterilized before use. Additional sterile components should be available in case of an unexpected need.

### INTRAOPERATIVE

1. Extreme caution should be used around the spinal cord and nerve roots. Damage to the nerves will cause loss of neurological functions.
2. Breakage, slippage, or misuse of instruments or implant components may cause injury to the patient or operative personnel.
3. The rods should not be repeatedly or excessively bent. The rods should not be reverse bent in the same location. Use great care to insure that the implant surfaces are not scratched or notched, since such actions may reduce the functional strength of the construct. If the rods are cut to length, they should be cut in such a way as to create a flat, non-sharp surface perpendicular to the midline of the rod. Cut the rods outside the operative field. Whenever possible, use pre-cut rods of the length needed.
4. Utilize an imaging system to facilitate surgery.
5. To insert a screw properly, a guide wire should first be used, followed by a sharp tap. Caution: Be careful that the guide-wire, if used, is not inserted too deep, becomes bent, and/or breaks. Ensure that the guide-wire does not advance during tapping or screw insertion. Remove the guide-wire and make sure it is intact. Failure to do so may cause the guide wire or part of it to advance through the bone and into a location that may cause damage to underlying structures.
6. Caution: Do not overlap or use a screw/bolt that is either too long or too large. Overtapping, using an incorrectly sized screw/bolt, or accidentally advancing the guidewire during tap or screw/bolt insertion, may cause nerve damage, hemorrhage, or the other possible adverse events listed elsewhere in this package insert. If screws/bolts are being inserted into spinal pedicles, use as large a screw/bolt diameter as will fit into each pedicle.
7. Bone graft must be placed in the area to be fused and graft material must extend from the upper to the lower vertebrae being fused.
8. To assure maximum stability, two or more CROSSLINK® plates or DTT Transverse Links on two bilaterally placed, continuous rods, should be used whenever possible.
9. Bone cement should not be used because the safety and effectiveness of bone cement has not been determined for spinal uses, and this material will make removal of the components difficult or impossible. The heat generated from the curing process may also cause neurologic damage and bone necrosis.
10. Before closing the soft tissues, provisionally tighten (finger tighten) all of the nuts or screws, especially screws or nuts that have a break-off feature. Once this is completed go back and firmly tighten all of the screws and nuts. Recheck the tightness of all nuts or screws after finishing to make sure that none loosened during the tightening of the other nuts or screws. Failure to do so may cause loosening of the other components.

### POSTOPERATIVE

The physician's postoperative directions and warnings to the patient, and the corresponding patient compliance, are extremely important.

1. Detailed instructions on the use and limitations of the device should be given to the patient. If partial weight-bearing is recommended or required prior to firm bony union, the patient must be warned that bending, loosening and/or breakage of the device(s) are complications which may occur as a result of excessive or early weight-bearing or muscular activity. The risk of bending, loosening, or breakage of a temporary internal fixation device during postoperative rehabilitation may be increased if the patient is active, or if the patient is debilitated or demented. The patient should be warned to avoid falls or sudden jolts in spinal position.
2. To allow the maximum chances for a successful surgical result, the patient or devices should not be exposed to mechanical vibrations or shock that may loosen the device

## Important Information on the CD HORIZON® Spinal System *continued*

construct. The patient should be warned of this possibility and instructed to limit and restrict physical activities, especially lifting and twisting motions and any type of sport participation. The patient should be advised not to smoke tobacco or utilize nicotine products, or to consume alcohol or non-steroidals or anti-inflammatory medications such as aspirin during the bone graft healing process.

- The patient should be advised of their inability to bend or rotate at the point of spinal fusion and taught to compensate for this permanent physical restriction in body motion.
- Failure to immobilize a delayed or non-union of bone will result in excessive and repeated stresses on the implant. By the mechanism of fatigue, these stresses can cause the eventual bending, loosening, or breakage of the device(s). It is important that immobilization of the spinal surgical site be maintained until firm bony union is established and confirmed by roentgenographic examination. If a state of non-union persists or if the components loosen, bend, and/or break, the device(s) should be revised and/or removed immediately before serious injury occurs. The patient must be adequately warned of these hazards and closely supervised to insure cooperation until bony union is confirmed.
- As a precaution, before patients with implants receive any subsequent surgery (such as dental procedures), prophylactic antibiotics may be considered, especially for high-risk patients.
- The CD HORIZON® Spinal System implants are temporary internal fixation devices. Internal fixation devices are designed to stabilize the operative site during the normal healing process. After the spine is fused, these devices serve no functional purpose and may be removed. While the final decision on implant removal is, of course, up to the surgeon and patient, in most patients, removal is indicated because the implants are not intended to transfer or support forces developed during normal activities. If the device is not removed following completion of its intended use, one or more of the following complications may occur: (1) Corrosion, with localized tissue reaction or pain; (2) Migration of implant position, possibly resulting in injury; (3) Risk of additional injury from postoperative trauma; (4) Bending, loosening and breakage, which could make removal impractical or difficult; (5) Pain, discomfort, or abnormal sensations due to the presence of the device; (6) Possible increased risk of infection; (7) Bone loss due to stress shielding; and (8) Potential unknown and/or unexpected long term effects such as carcinogenesis. Implant removal should be followed by adequate postoperative management to avoid fracture, re-fracture, or other complications.
- Any retrieved devices should be treated in such a manner that reuse in another surgical procedure is not possible. As with all orthopedic implants, the CD HORIZON® Spinal System components should never be reused under any circumstances.

### PACKAGING

Packages for each of the components should be intact upon receipt. If a loaner or consignment system is used, all sets should be carefully checked for completeness and all components including instruments should be carefully checked to ensure that there is no damage prior to use. Damaged packages or products should not be used, and should be returned to Medtronic.

### CLEANING AND DECONTAMINATION

Unless just removed from an unopened Medtronic package, all instruments and implants must be disassembled (if applicable) and cleaned using neutral cleaners before sterilization and introduction into a sterile surgical field or (if applicable) return of the product to Medtronic. Cleaning and disinfecting of instruments can be performed with aldehyde-free solvents at higher temperatures. Cleaning and decontamination must include the use of neutral cleaners followed by a deionized water rinse.

Note: certain cleaning solutions such as those containing formalin, glutaraldehyde, bleach and/or other alkaline cleaners may damage some devices, particularly instruments; these solutions should not be used. Also, many instruments require disassembly before cleaning.

All products should be treated with care. Improper use or handling may lead to damage and/or possible improper functioning of the device.

### STERILIZATION

Unless marked sterile and clearly labeled as such in an unopened sterile package provided by the company, all implants and instruments used in surgery must be sterilized by the hospital prior to use. Remove all packaging materials prior to sterilization. Only sterile products should be placed in the operative field. Unless specified elsewhere, these products are recommended to be steam sterilized by the hospital using one of the sets of process parameters below:

METHOD	CYCLE	TEMPERATURE	EXPOSURE TIME
Steam	Pre-Vacuum	270°F (132°C)	4 Minutes
Steam	Gravity	250°F (121°C)	60 Minutes
Steam*	Pre-Vacuum*	273°F (134°C)*	20 Minutes*
Steam*	Gravity*	273°F (134°C)*	20 Minutes*

NOTE: Because of the many variables involved in sterilization, each medical facility should calibrate and verify the sterilization process (e.g., temperatures, times) used for their equipment. \*For outside the United States, some non-U.S. Health Care Authorities recommend sterilization according to these parameters so as to minimize the potential risk of transmission of Creutzfeldt-Jakob disease, especially of surgical instruments that could come into contact with the central nervous system.

### PRODUCT COMPLAINTS

Any Health Care Professional (e.g., customer or user of this system of products), who has any complaints or who has experienced any dissatisfaction in the product quality, identity, durability, reliability, safety, effectiveness and/or performance, should notify the distributor, Medtronic. Further, if any of the implanted spinal system component(s) ever "malfunctions," (i.e., does not meet any of its performance specifications or otherwise does not perform as intended), or is suspected of doing so, the distributor should be notified immediately. If any Medtronic product ever "malfunctions" and may have caused or contributed to the death or serious injury of a patient, the distributor should be notified immediately by telephone, FAX or written correspondence. When filing a complaint, please provide the component(s) name and number, lot number(s), your name and address, the nature of the complaint and notification of whether a written report from the distributor is requested.

### FURTHER INFORMATION



**Medtronic B.V.**  
Earl Bakkenstraat 10  
6422 PJ Heerlen  
The Netherlands  
Tel: + 31 45 566 80 00



**Medtronic Sofamor Danek USA, Inc.**  
1800 Pyramid Place  
Memphis, TN 38132  
Telephone 800 933 2635 (In U.S.A.)  
901 396 3133 (Outside of U.S.A.)  
Fax 901 396 0356

Recommended directions for use of this system (surgical operative techniques) are available at no charge upon request. If further information is needed or required, please contact MEDTRONIC.

©2007 Medtronic Sofamor Danek USA, Inc. All rights reserved.

## Notes



[www.medtronic.com](http://www.medtronic.com)

**Medtronic**

Spinal and Biologics Business  
Worldwide Headquarters

2600 Sofamor Danek Drive  
Memphis, TN 38132

1800 Pyramid Place  
Memphis, TN 38132

(901) 396-3133  
(800) 876-3133  
Customer Service: (800) 933-2635

For more information visit  
[www.myspinetools.com](http://www.myspinetools.com)

The surgical technique shown is for illustrative purposes only. The technique(s) actually employed in each case will always depend upon the medical judgment of the surgeon exercised before and during surgery as to the best mode of treatment for each patient.

Please see the package insert for the complete list of indications, warnings, precautions, and other important medical information.

The NIM-ECLIPSE® Spinal System is manufactured by Axon Systems, Inc. Distributed by Medtronic.



**Medtronic**